

PWSHK-S24-400

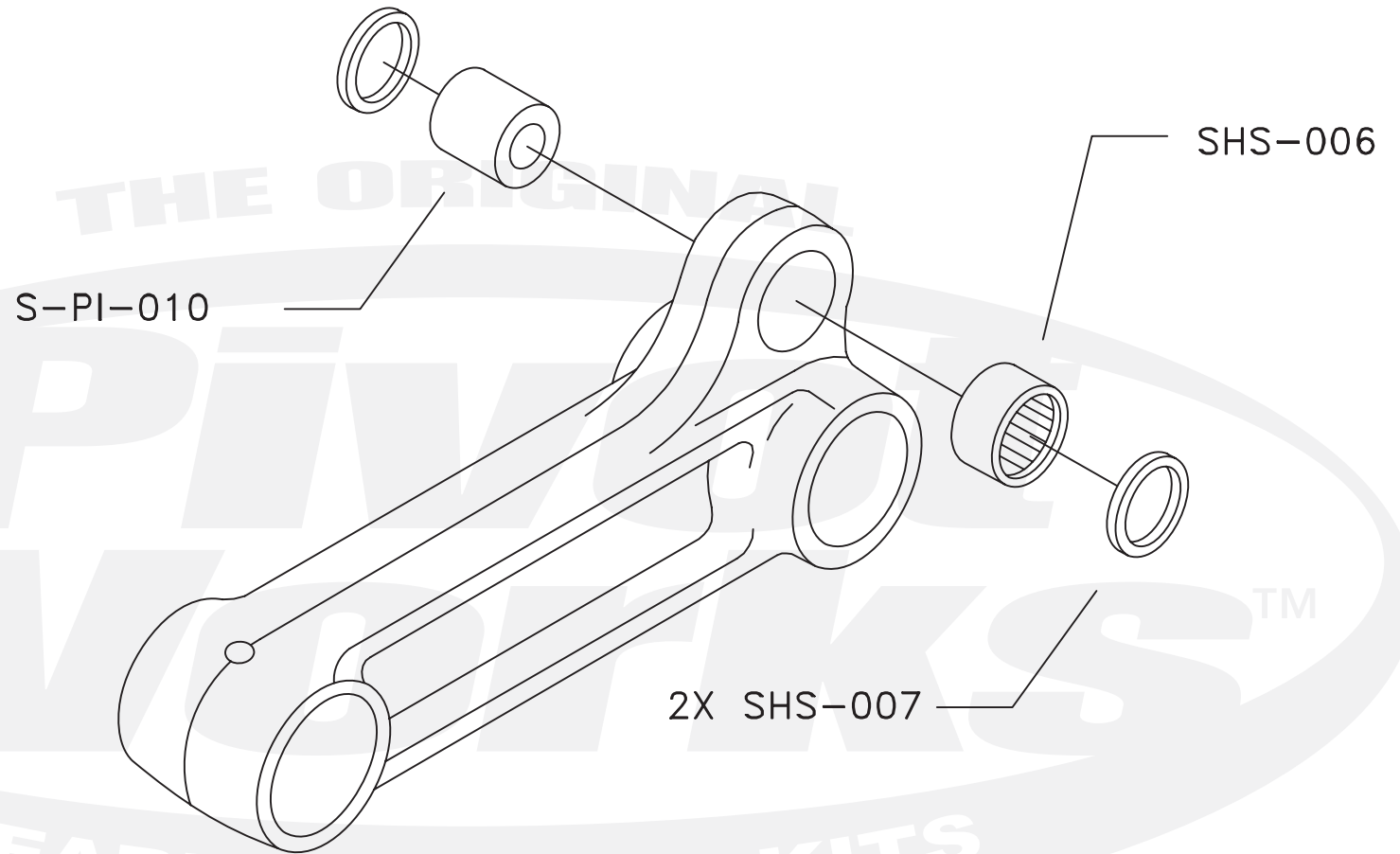

Qty.	Part Number	Description
1	S-PI-010	Pin
1	SHS-006	Bearing
2	SHS-007	Seal